



Changes for the Better

AIR CONDITIONING SYSTEMS

CITY MULTI

Air to Water series

5th edition

for a greener tomorrow



Mitsubishi Electric's Air to Water Series

Our solution to COOLING, HEATING and HOT WATER SUPPLY

In the recent years, the need to be more energy conscious and environmentally responsible has become increasingly important to us all.

As a leading manufacturer of air conditioning systems, Mitsubishi Electric constantly strives to meet and exceed the increasing demands placed on the industry. Through research and development for the future, we proudly introduce our new Air to Water system which uses water as a heating and cooling medium for space heating/cooling and hot water supply applying the heat pump and heat recovery technology.

● Accelerating global warming

The increase of the carbon dioxide (CO₂) concentration in the earth atmosphere is considered to be one of the main factors concerning global warming.

The earth's average temperature has risen more than 0.8°C over the last century, resulting in extreme weather. It is estimated that the global temperature would rise by 1.1-6.4°C by the year 2100. (Fig.1)

Temperature difference (°C)

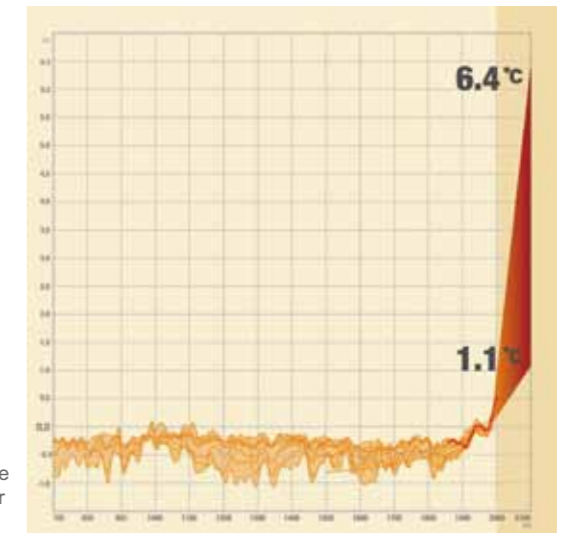

Fig.1 Change in temperature from the year 700 to 2100 (observation and prediction)
Source : "The Fourth Assessment Report" published by Intergovernmental Panel on Climate Change (IPCC) from website of Japan Center for Climate Change Actions (<http://www.jccca.org/>)

● Major cause of CO₂ emission

Fig. 2 shows a breakdown of CO₂ emissions in Japan. As the graph shows, industrial, residential, commercial and transportation sectors are the major sources of CO₂ emissions.

The residential and commercial sectors account for more than 30% of all energy use. With many people spending much of their time indoors at home or work, it is not surprising that buildings account for a large percentage of all energy use. In buildings, especially energy used for air conditioning (cooling and heating) and hot water accounts for large percentage of all energy use.

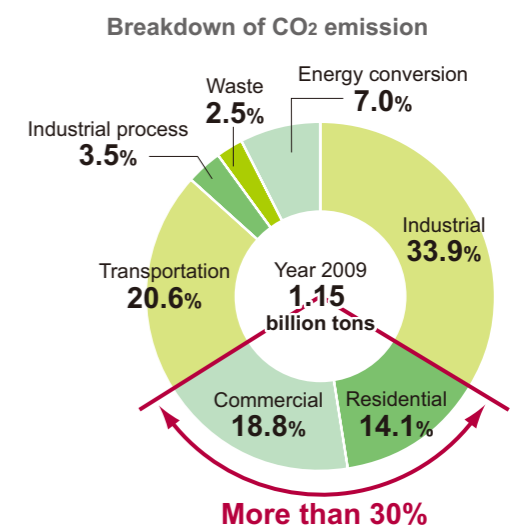

Fig.2 Percentage of energy consumed by each economic sector in Japan
Source : "Emissions of Greenhouse Gases in Japan in 2009" published by Green house Gas Inventory Office of Japan from website of Japan Center for Climate Change Actions (<http://www.jccca.org/>)

This means that there is a great scope for reducing energy use through better-designed buildings and more efficient heating, cooling and hot water systems.

CONTENTS

Key technologies of Air to Water series	3
Mitsubishi Electric's Solution	5
Mitsubishi Electric's Proposal	13
Frequently asked questions	17
Specification	19

Key technologies of Air to Water series

Air to Water series making the most of Heat Pump and Heat Recovery technology

Heat pump and heat recovery technologies are already well known in the air conditioning market and proved to be efficient for cooling and heating. Mitsubishi Electric has now designed Air to Water (ATW) series utilizing the technologies to provide hot water.

Here is an overview of the technology that roots in ATW system

Heat pump technology

- >Remarkable energy consumption efficiency
- >Generating much larger heat energy than the input energy
- >Heating or cooling operation

Heat recovery technology

- >Effective use of waste heat
- >Heating and cooling simultaneous operation

Both technologies, compared to conventional system of boilers, not only do they have incredible design flexibility, excellent use of energy and reduce CO₂ emissions, there is a further reduction in capital costs. Negating the need for the installation of gas supply entirely, ATW series can provide hot water by means of electric.

Basics of air conditioning

HEAT PUMP

- >Remarkable energy consumption efficiency
- >Generating much larger heat energy than the input energy
- >Heating or cooling operation

From energy output side, the operation characteristics of a heat pump are different to conventional systems (such as electric/gas/oil boilers or electric heaters). With conventional systems, 1kW of input energy provides less than 1kW of output energy or heat. With a heat pump system, every 1kW of input energy is converted into an average of 2~5times of output energy or heat by absorbing heat from outdoor air. Also, a heat pump, as its name shows, "pumps up" heat from a low temperature source, outdoor air, for example, and transfers it at a higher temperature in a building, making it more efficient as conventional boilers and a natural choice for low cost heating and hot water.

Traditional Boiler System

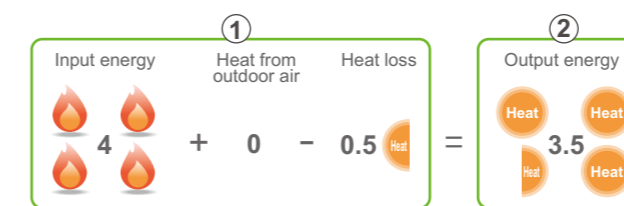
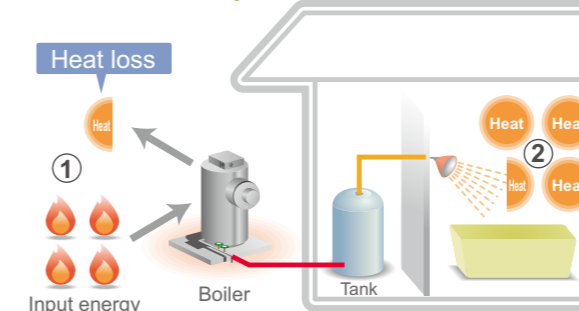

Heat Pump System

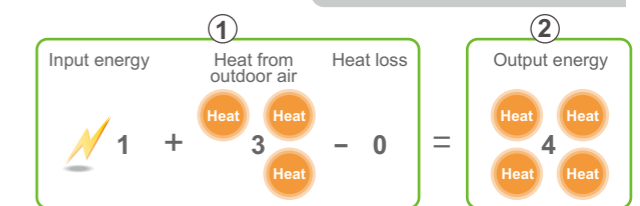
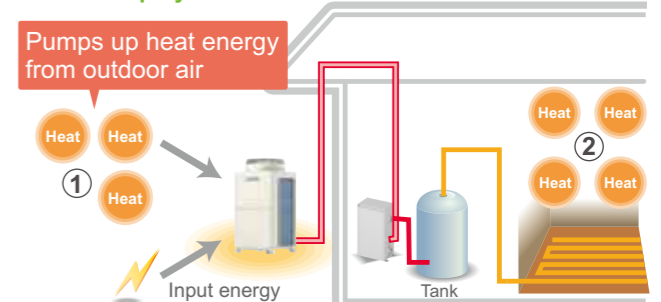

HEAT RECOVERY

- >Effective use of waste heat
- >Heating and cooling simultaneous operation

Heat recovery system can provide an ideal solution when taking a look at the system from energy exhaust point of view. This is because air conditioning and hot water are expected to use throughout the year and with a heat recovery system, exhausted heat from the indoor unit is diverted to be reused in a different purpose. For example, wasted heat from cooling operation is reused for heating or hot water supply, and wasted heat from heating operation or hot water supply is reused for cooling operation or cold water supply. The more frequently heating and cooling simultaneous operation is carried out, the higher the energy saving effect becomes.

Traditional Boiler System + Cooling Only Air Conditioner

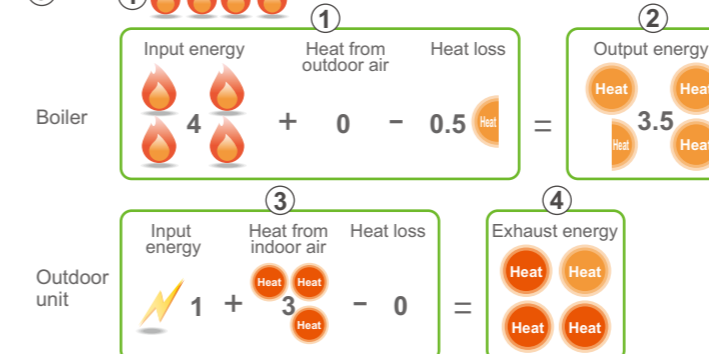
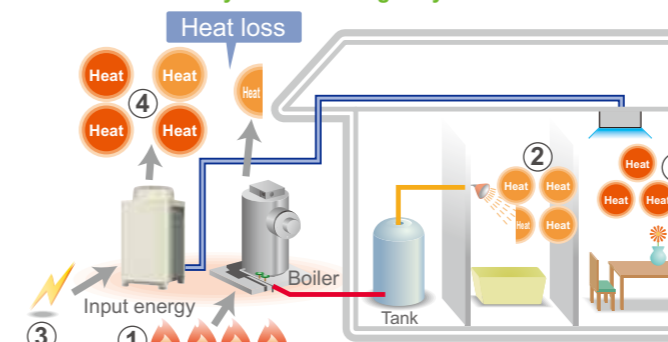

Heat Recovery System

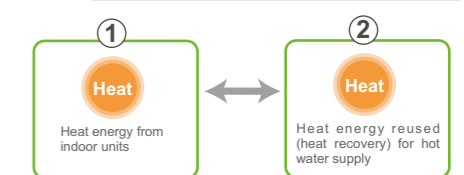
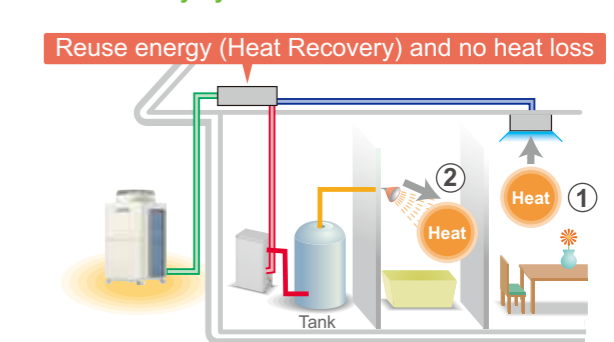

Mitsubishi Electric's Solution

Air to Water advanced system explained

Air To Water (ATW) series offers the choice between two types of units; a Booster unit and a HEX (Heat Exchanger) unit. A Booster unit offers hot water to a maximum of 70°C and HEX unit offers 45°C in heating and down to 8°C in cooling. Applying heat pump and heat recovery technology to provide hot water, the units are suitable for residences, office buildings, restaurants or hotels, providing an optimal environment while benefiting from reduced running costs and less impact on environment.

ATW system consists of an outdoor unit, a BC controller when connected with R2 series, ATW unit, indoor unit and a controller.

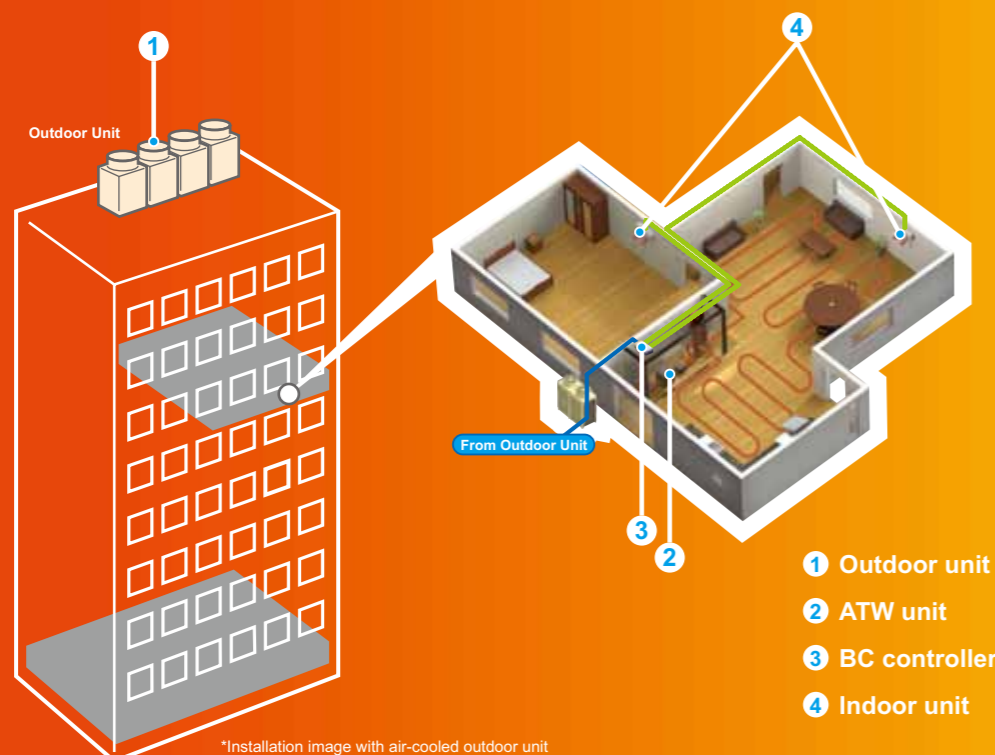

*Installation image with air-cooled outdoor unit

1 OUTDOOR UNIT

CITY MULTI outdoor units, both air cooled heat pump/heat recovery or water-cooled heat pump/heat recovery can be connected to the ATW system depending on the system structure.

AIR COOLED outdoor unit

► Lineup

CITY MULTI

Heat pump

Y series	8HP~50HP (22.4kW~140.0kW)
EP(High COP) series	8HP~36HP (22.4kW~101.0kW)
HP(ZUBADAN) series	8HP~20HP (22.4kW~56.0kW)
Replace series	8HP~36HP (22.4kW~101.0kW)
S series	4HP~6HP (11.2kW~15.5kW)

Heat recovery

R2 series	8HP~36HP (22.4kW~101.0kW)
EP(High COP) series	8HP~28HP (22.4kW~80.0kW)
Replace series	8HP~12HP (22.4kW~33.5kW)



► Features

CITY MULTI units are designed to be an efficient, fully customizable solution for providing comfort environment inside a building. Broader model line up is prepared from standard Y/R2 series, high COP series and ZUBADAN series to diverse requirements.

WATER COOLED outdoor unit

► Lineup

CITY MULTI

Heat pump

WY series	8HP~36HP (22.4kW~101.0kW)
-----------	------------------------------

Heat recovery

WR2 series	8HP~24HP (22.4kW~69.0kW)
------------	-----------------------------



► Features

CITY MULTI water cooled systems use water as a heat exchange medium and can be installed inside, rather than outside a building. The water can be delivered at optimized temperature and volumes, which allows great flexibility and energy efficiency. They are ideally suited for use in temperate and cooler climates since heat exchange with the outside air is not required.



► R410A refrigerant

R410A refrigerants are safe with zero ODP(Ozone Depletion Potential). Accordingly, our systems require less energy to run, and have a significantly lower indirect global warming potential.

***Do not use refrigerant other than the type indicated in the manuals provided with the unit and on the nameplate.**
 - Doing so may cause the unit or pipes to burst, or result in explosion or fire during use, during repair, or at the time of disposal of the unit.
 - It may also be in violation of applicable laws.
 - MITSUBISHI ELECTRIC CORPORATION cannot be held responsible for malfunctions or accidents resulting from the use of the wrong type of refrigerant.

— Inverter driven compressor ◀

The compressor varies its speed to match the indoor cooling or heating demand and only consumes the energy that is required. When an inverter driven system is operating at partial load, the energy efficiency of the system is significantly higher than that of a standard fixed speed, non inverter system.



2 ATW UNIT

BOOSTER UNIT

Benefiting from the heat recovery operation of the CITY MULTI R2 system, Booster unit converts energy from the air to higher temperatures suitable for supplying hot water and results in virtually no energy waste.

Connectable to

CITY MULTI
R2/WR2 series
REPLACE MULTI
R2 series

Applications

best for sanitary
water, shower, etc.

Operation

up to 70°C

SYSTEM OUTLINE

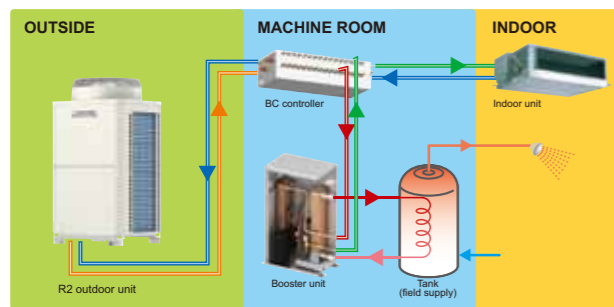

The Booster unit is connected to a BC controller with refrigerant pipes, and to the water tank with water pipes. The waste heat from cooling operation is utilized for heating operation which provides hot water.

Red — High pressure gas refrigerant
Orange — High pressure 2-phase refrigerant
green — High pressure liquid refrigerant
Blue — Low pressure gas refrigerant

HEX UNIT

By utilizing waste heat from the R2 outdoor unit for heating operation in HEX unit, it is possible to supply hot water with high efficiency. Also, even when connected with the Y series, it provides efficient operation compared to a conventional system.

Connectable to

CITY MULTI
R2/WR2/
Y/WY/ZUBADAN series
REPLACE MULTI
R2/Y series

Applications

best for floor
heating, panel
heater, fan-coil
unit(AHU), etc.

Operation

hot water up to 45°C
cold water down to
8°C

<SYSTEM OUTLINE HEX unit with R2 series>

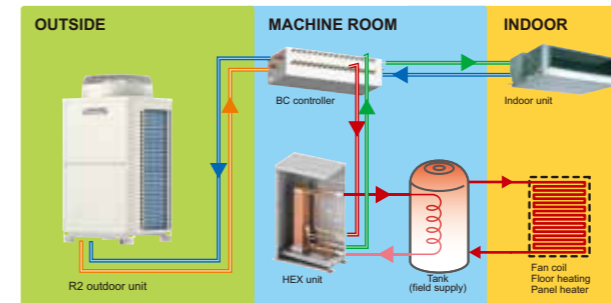

HEX unit is connected to BC controller with refrigerant pipes, and to the water tank with water pipes. HEX unit is not equipped with a compressor.

Red — High pressure gas refrigerant
Orange — High pressure 2-phase refrigerant
green — High pressure liquid refrigerant
Blue — Low pressure gas refrigerant

*The image is a system example in case of heating mode.

*The necessity of the tank depends on the system configuration.

What makes Booster unit unique?

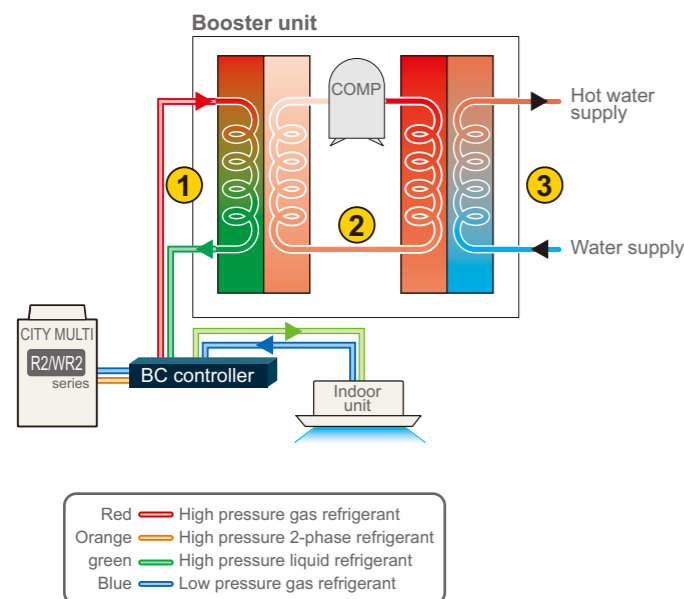

Refrigerant flow

① From the BC controller, high pressure R410A gas refrigerant is delivered to the Booster unit to exchange heat with the low pressure R134a liquid refrigerant circulating through ② and returns to the BC controller as a high pressure liquid refrigerant.

② Refrigerant R134a circulates inside the two plate heat exchangers inside the unit. Temperature rises as low-pressure R134a gas refrigerant is compressed by the compressor and becomes high-pressure gas refrigerant.

Water supply

③ Water entering the Booster unit exchanges heat with high-pressure R134a gas refrigerant. The hot water circulates to heat the water inside the tank which will be used for showers, sanitary water, etc.

Red — High pressure gas refrigerant
Orange — High pressure 2-phase refrigerant
green — High pressure liquid refrigerant
Blue — Low pressure gas refrigerant

What makes HEX unit unique with R2/WR2 series?

Hot water supply

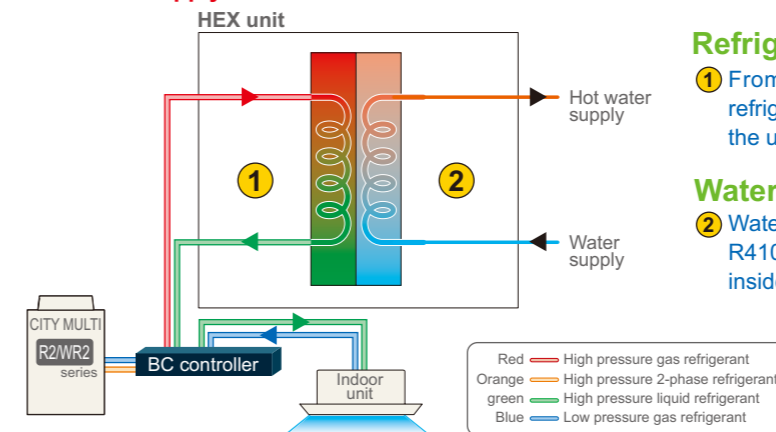

Refrigerant flow

① From the BC controller, high pressure R410A gas refrigerant is delivered to the HEX unit and returns to the unit as high pressure liquid refrigerant.

Water supply

② Water entering the HEX unit exchanges heat with the R410A refrigerant and water circulates to heat the water inside the tank.

Red — High pressure gas refrigerant
Orange — High pressure 2-phase refrigerant
green — High pressure liquid refrigerant
Blue — Low pressure gas refrigerant

Cold water supply

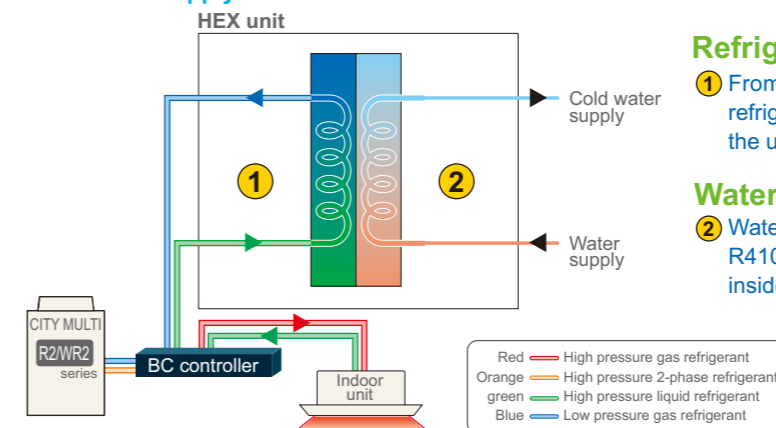

Refrigerant flow

① From the BC controller, high pressure R410A liquid refrigerant is delivered to the HEX unit and returns to the unit as low pressure gas refrigerant.

Water supply

② Water entering the HEX unit exchanges heat with the R410A refrigerant and water circulates to cool the water inside the tank.

Red — High pressure gas refrigerant
Orange — High pressure 2-phase refrigerant
green — High pressure liquid refrigerant
Blue — Low pressure gas refrigerant

HEX UNIT

<SYSTEM OUTLINE HEX unit with Y series>

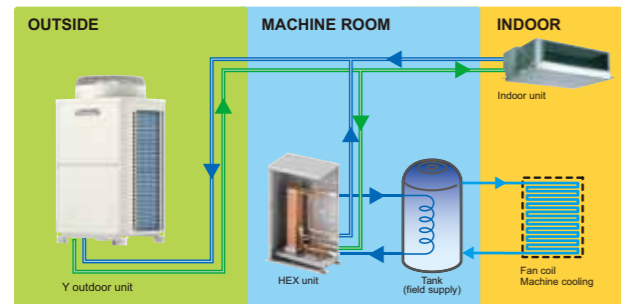

HEX unit is connected to Y outdoor unit with refrigerant pipes, and to the water tank with water pipes. HEX unit is not equipped with a compressor.

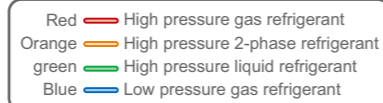

What makes HEX unit unique with Y/WY series?

Hot water supply

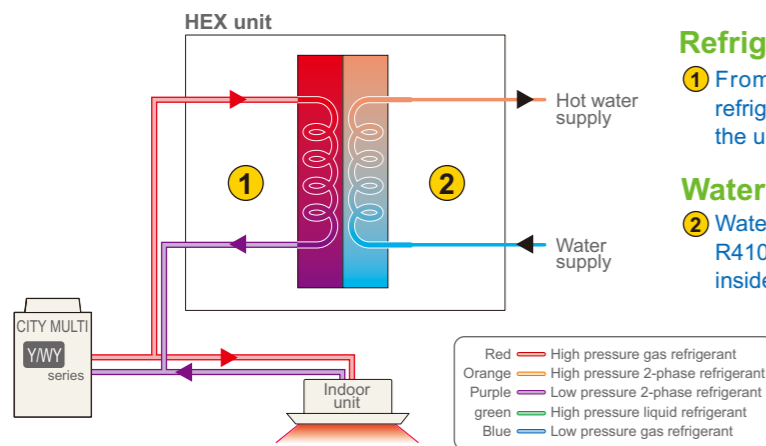

Refrigerant flow

① From the outdoor unit, high pressure R410A gas refrigerant is delivered to the HEX unit and returns to the unit as low pressure 2-phase refrigerant.

Water supply

② Water entering the HEX unit exchanges heat with the R410A refrigerant and water circulates to heat the water inside the tank.

Cold water supply

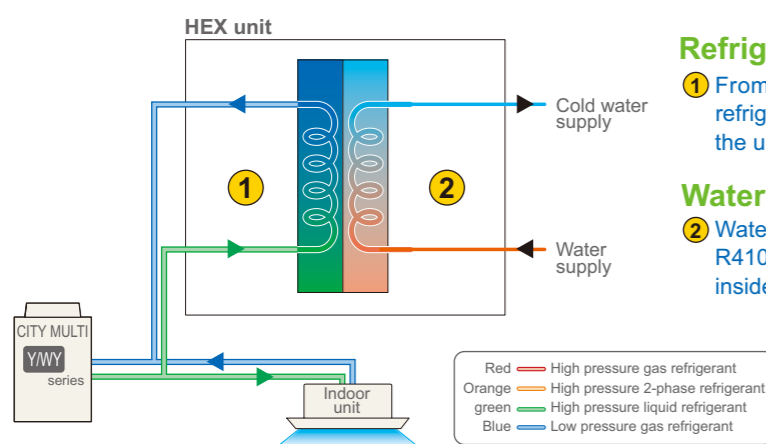

Refrigerant flow

① From the outdoor unit, high pressure R410A liquid refrigerant is delivered to the HEX unit and returns to the unit as low pressure gas refrigerant.

Water supply

② Water entering the HEX unit exchanges heat with the R410A refrigerant and water circulates to cool the water inside the tank.

③ BC CONTROLLER

To connect R2/WR2 series outdoor units and ATW indoor units, a BC controller or WCB (Water system Connection Box), which is a simple version of a BC controller can be used.

		BC controller	WCB
Connectable ATW system		Booster/HEX	
Outdoor unit		R2*/WR2	
	Connectable series		
	Connectable capacity	P200-P900	P200-P350
	Connectable qty	1-50	1-30
ATW/ Indoor unit	Connection method	With BC's port	By branch pipe
	Operation mode	Cooling AND heating	Cooling OR heating
Product image			

*WCB cannot be connected to XL module outdoor unit.

④ INDOOR UNIT

In an ATW system, standard CITY MULTI indoor units can also be connected.

CITY MULTI selection of indoor units provide a wide range of indoor units to meet the requirements of all room types. Units are available in Ceiling Cassette, Ceiling Concealed Ducted, Ceiling Suspended, and Wall Mounted & Floor mounted versions.

<p>Ceiling Cassette 4-Way Airflow</p> <p>PLFY-VBM,VCM</p>	<p>Ceiling Cassette 2-Way Airflow</p> <p>PLFY-VLMD</p>	<p>Ceiling Cassette 1-Way Airflow</p> <p>PMFY</p>	<p>Ceiling Concealed Middle Static Pressure</p> <p>PEFY-VMA(L)</p>
<p>Ceiling Concealed Low Static Pressure</p> <p>PEFY-VMR</p>	<p>Ceiling Concealed High Static Pressure</p> <p>PEFY-VMS1(L)</p>	<p>Ceiling Suspended</p> <p>PCFY</p>	
<p>Wall Mounted</p> <p>PKFY</p>	<p>Floor Standing Exposed</p> <p>PFFY-VKM</p>	<p>Floor Standing Concealed</p> <p>PFFY-VLRM PFFY-VLRMM</p>	

5 CONTROL

Remote Controller

The PAR-W21MAA remote controller is specially designed for Air to Water system.

BASIC FUNCTIONS

- >Operation mode setting
- >Water temperature setting
- >Temperature range setting
- >Local operation setting
- >Weekly schedule setting
- >Error code display



Centralized Controller

With a new designed color liquid crystal display and touch panel, AG-150A can centrally control up to 150 units via an expansion controller.

BASIC FUNCTIONS

- >Operation setting
- >Water temperature setting
- >Local operation setting
- >Error code display

Booster / HEX unit icon shown on AG-150A screen



System Structure (Remote controller + Centralized controller)

Centralized controller AG-150A can centrally control up to 150 units via an expansion controller.

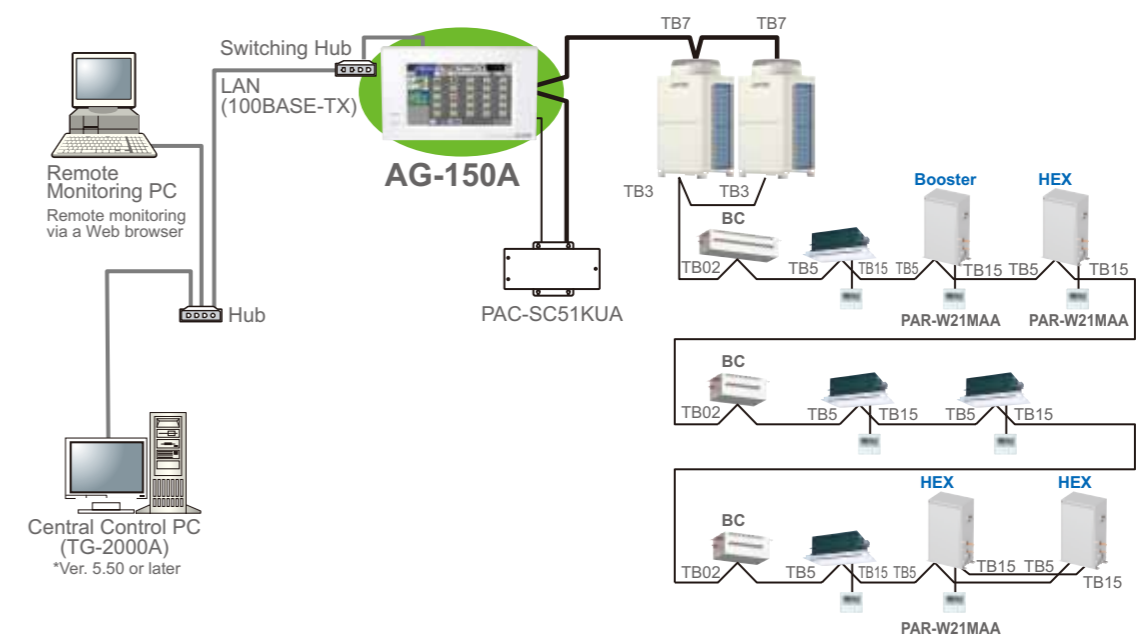

Advanced touch controller

With backlit 5-inch color liquid crystal display, AT-50A can centrally control up to 50 units. It also provides easy operation with touch panel.

FUNCTIONS

- >Operation mode switching
- >Water temperature setting
- >Weekly and daily schedule setting
- >Error code display



System Structure (Remote controller + Advanced touch controller)

Advanced touch controller AT-50A can control up to 50 units from one location.

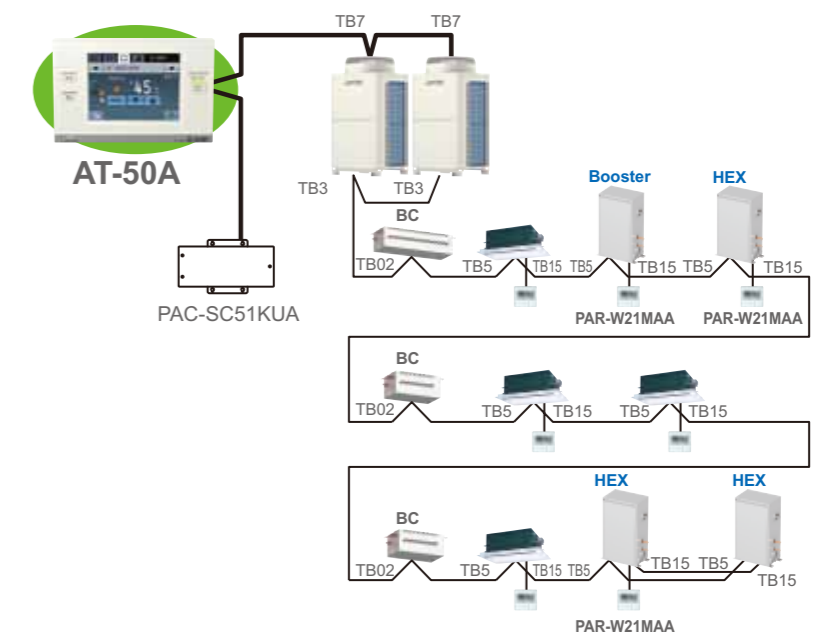

Mitsubishi Electric's Proposal

How Air to Water system can actually apply to applications to satisfy the expectations.

The Air to Water system; Mitsubishi Electric's solution to cooling, heating and hot water supply, is an attractive solution utilizing the heat pump and heat recovery technology.

The fact that the Air to Water advanced technology can greatly reduce CO₂ emissions is appealing amid the global and national pressures to be more environmentally responsible.

With both an innovatory technology and high environmental concerns, Air to Water systems are ideal for use in various applications to provide air conditioning or hot water depending on requirement.

● Application example

The application examples here indicate why ATW systems are chosen and how the great potential offered by using ATW systems can be best utilized.

RESTAURANT

Reason for ATW

- >Hot water is almost always required in the kitchen.
- >Waste heat from the kitchen can be used to cool the dining hall in the summer, increasing efficiency in the system.

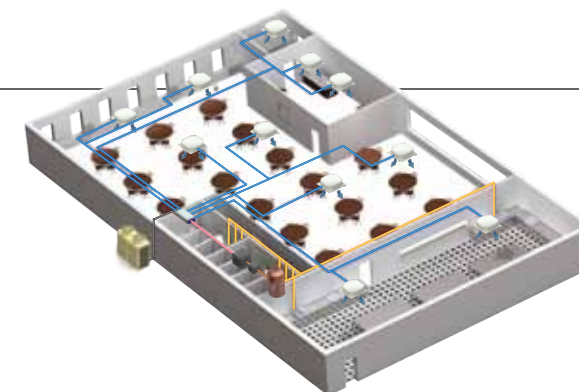

HEALTH CLUBS

Reason for ATW

- >Gym space requires year-round cooling.
- >Swimming pools and shower rooms require hot water.

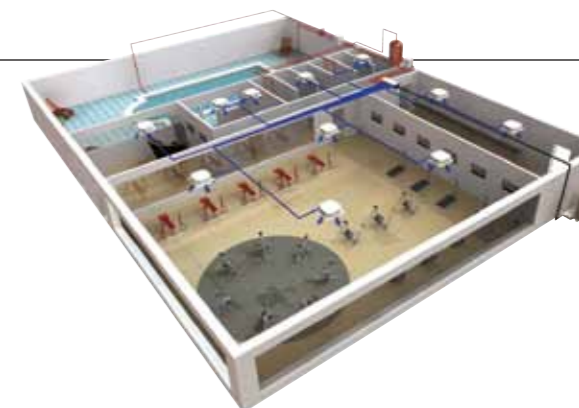

OFFICE

Reason for ATW

- >Different requirements for different tenants/rooms. Meaning cooling/heating/hot water is expected throughout the year.
- >In the winter, hot water for small kitchens using the waste heat from cooling operation in rooms with numbers of computer.
- >In the summer, cooling operation performed in all rooms while hot water is available in small kitchens.



RESIDENCE

Reason for ATW

- >Hot water requirement throughout the year. For shower and kitchen.
- >Can be used for under floor heating in winter seasons and cooling in summer seasons.

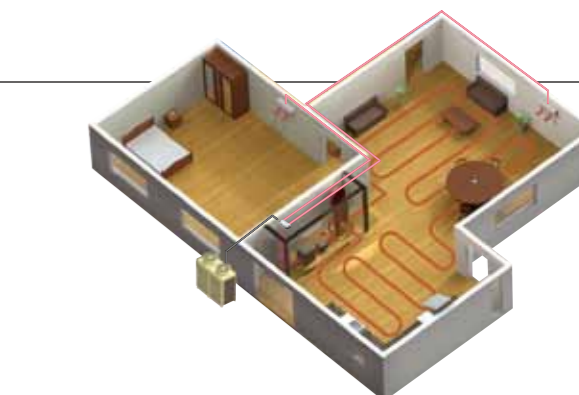

● Case study

The actual case study reveals the background of why ATW system was proposed and chosen as a solution to match the different needs of the people and the building.

CASE STUDY 1

Application : Canteen
Country : United Kingdom

Unit information

Outdoor unit : Air-cooled R2 (High COP) series ×1, BC controller ×1
ATW unit : Booster unit ×1 Indoor unit : Ceiling concealed type ×2
Control : ATW controller ×1, MA remote controller ×1

●Background

ATW system is installed in the Mitsubishi Electric UK's head office located in Hatfield. The office has an on-site restaurant that can seat 100 people and serves cooked meals 5 days a week between 8am – 10:30am and every afternoon from 12pm – 2pm.

With the restaurant being popular with employees, the kitchen staff are constantly busy preparing and serving meals from early morning until mid-afternoon. Therefore the kitchen area requires constant cooling during these times and a sufficient supply of hot water to meet their needs.

●Previous Equipment

The previous equipment that was providing cooling to the kitchen area as well as hot water was installed in 1998. The air conditioning system was providing 20kW of cooling to the kitchen area from a power input of 8.8kW therefore giving a COP of 1.87. This equated to a 15% reduction in capacity after 10 years and a 15% increase in power consumption after 10 years making the system less energy efficient.

The hot water demand for the kitchen is 650ℓ per day. Previously, hot water was supplied to the kitchen from a standard cylinder with a standard size surface area of coil and 2 immersion heaters. The cylinder was able to provide 9kW of hot water from an input of 9kW therefore giving a COP of 0.98.

With the decrease in equipment efficiency over the 10 years since installation it was clear that a new, more efficient and cost effective solution was needed.



CASE STUDY 2

Application : Golf club
Country : Italy

Unit information

Outdoor unit : Air-cooled R2 series ×3, Air-cooled Y series ×1, BC controller ×4
ATW unit : Booster unit ×3, HEX unit ×3 Indoor unit : Ceiling cassette (4-way) type ×26
Control : ATW controller ×6, ME remote controller ×30
Other : OA processing unit ×4

●Background

The consultant proposed the Air to Water and CITY MULTI system to the golf club owner highlighting the advantages that the Air to Water system can produce hot water without a boiler and has a low emission of CO₂.



CASE STUDY 3

Application : Restaurant
Country : Italy

Unit information

Outdoor unit : Air-cooled R2 series ×5, BC controller ×5
ATW unit : Booster unit ×3 Indoor unit : Floor mounted concealed type ×18
Control : AG-150A ×1, ATW controller ×3, ME remote controller ×27, Power supply unit ×1
Other : OA processing unit ×9

●Background

The restaurant required air conditioning, fresh air, and sanitary water. As a perfect solution that can provide all three, the consultant proposed the Air to Water system+CITY MULTI+OA processing unit.

With the combination of Mitsubishi Electric's product lineup, the system can provide hot water without a boiler and air conditioning with a high COP. What's more, with the OA processing unit in a system, suitable ventilation with top quality air and energy saving environment is created.



Frequently asked questions

ENVIRONMENT

Q1. How can air source heat pumps alleviate fuel poverty?

Because of the energy conversion efficiencies within an air source heat pump and heat recovery, the running costs against the other main gas, oil or direct electric heating systems are significantly reduced.

Q2. How does ATW system help reduce carbon emissions?

Comparing COP of systems that can produce hot water, boiler has a COP of approximately 1.0 and ATW system 3.0. This means that boilers consume a tripled amount of electrical energy. Taking this into account, ATW system emits far less CO₂ than even the highest efficiency gas boilers.

INSTALLATION

Q3. How easy is it to install ATW system?

Consider ATW units as one type of indoor unit in a VRF system. For example, Booster unit can be installed by connecting the unit by either a BC controller or a WCB. The unit can even be added to an existing VRF system.

Q4. How much space is required for the ATW unit?

ATW units (Booster/HEX unit) must be installed inside a building. The units are approximately 800mm tall by 450mm wide and has a depth of 300mm. Sufficient service space 600mmx925mm is required at the front of the unit.

Q5. Where does the gas boiler go in the installation?

There is no need to have a gas or oil fired boiler in an ATW installation.

Q6. What kind of protection is required for sanitary hot water?

We do not recommend hot water for drinking. The hot water is circulating and not supplied for drinking purposes. It is also recommended that hot water to be stored above 60°C to prevent microbial growth (legionella). Using an optional controller PAR-W21MAA weekly schedule function (up to 6 settings/day in 1 minute increment) can set hot water above 60°C regularly to sanitize the system.

Q7. Are there any special requirements during Winter?

Commonly, an inhibitor is put in the system to prevent from freezing but with the ATW system, Anti-freeze function is available. The Anti-freeze mode can set the heating temperature range between 10°C~45°C enabling the unit to maintain low water temperature to prevent water pipes from freezing.

OPERATION

Q8. What difference will the users experience if they use ATW system instead of a traditional boiler?

One of the difference users are likely to experience is that it saves their time and cut costs. This is because ATW system works with CITY MULTI outdoor units operated on electricity and not requiring liquid or gas fuels to be supplied regularly as in traditional boilers.

Q9. Will ATW system work when it's cold outside?

ATW system works with CITY MULTI outdoor units which heating operation ranges down to as low as -20°C (Y/R2 series). Moreover, with CITY MULTI air-cooled ZUBADAN series, heating operation pushes its boundaries down to -25°C.

Q10. Are ATW units noisy?

Even though ATW units will be installed inside the building, the units have a sound pressure level of 44dB with Booster unit and 29dB with HEX unit which is unlikely to be disturbing.

Q11. Will installing ATW system be cost saving?

The running costs are lower because of the high efficient heat pump and heat recovery technology. They are both refrigerant based system, (like a refrigerator) when compared with the boiler system, fuel costs can be cut fundamentally. The heat pump system can absorb low grade heat from the air (air source) or water (water source), and raise its temperature efficiently to be suitable for space heating and/or hot water. The heat recovery system reuses wasted heat from cooling operation for heating or hot water supply, and wasted heat from heating operation or hot water supply is reused for cooling operation or cold water supply. The cost saving effect is higher the more frequently heating and cooling simultaneous operation is carried out. Moreover, with a "Heating ECO mode" available by setting Dip Switch, outlet water temperature can automatically change based on outdoor temperature to provide only the required heating and supply hot water.

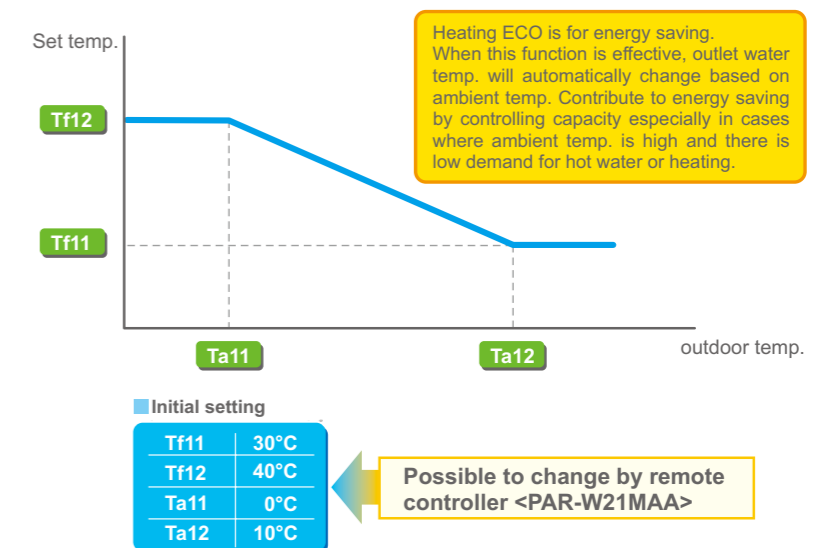

Specification

ATW UNIT Booster Unit



Model		PWFY-P100VM-E-BU	
Power source		1 - phase 220 - 230 - 240V 50 / 60Hz	
Heating capacity (Nominal)	*1 kW	12.5	
	*1 kcal / h	10,800	
	*1 BTU / h	42,700	
Power input	kW	2.48	
	Current input	A	
		11.63 - 11.12 - 10.66	
Temp. range of heating	Outdoor unit/Heat source unit condition	W.B. -20~32°C (-4~90°F) R2-series	
		- 10~45°C (50~113°F) WR2-series	
	Booster unit inlet water temp.	- 10 ~ 70°C (50 ~ 158°F)	
Connectable outdoor unit/heat source unit	Total capacity	50~100% of outdoor unit/heat source unit capacity	
	Model / Quantity	R2 (Standard, Hi-COP), Replace R2, WR2 series only	
Sound pressure level (measured in anechoic room)		dB <A> 44	
Diameter of refrigerant pipe	Liquid	mm (in.) ø9.52 (ø3/8") Brazed	
	Gas	mm (in.) ø15.88 (ø5/8") Brazed	
Diameter of water pipe	Inlet	mm (in.) PT3/4 Screw	
	Outlet	mm (in.) PT3/4 Screw	
Field drain pipe size	mm (in.)	ø32 (1-1/4")	
External finish		NO	
External dimension H x W x D		mm 800 (785 without legs) x 450 x 300	
		in. 31-1/2" (30-15/16" without legs) x 17-3/4" x 11-13/16"	
Net weight		kg (lbs) 60 (133)	
Compressor	Type	Inverter rotary hermetic compressor	
	Maker	MITSUBISHI ELECTRIC CORPORATION	
	Starting method	Inverter	
	Motor output	kW 1.0	
	Lubricant	NEO22	
Circulating water	Operation volume Range	m³ / h 0.6 ~ 2.15	
	Protection on internal circuit (R134a)	High pressure protection High pressure sensor, High pressure switch at 3.60 MPa (601 psi) Inverter circuit (COMP) Over - heat protection, Over - current protection Compressor Discharge thermo protection, Over - current protection	
Refrigerant	Type x original charge	*2 R134a x 1.1kg (0.50lb)	
	Control	LEV	
Design pressure	R410A	MPa 4.15	
	R134a	MPa 3.60	
	Water	MPa 1.00	
Drawing	External	WKB94L762	
	Wiring	WKE94C229	
Standard attachment	Document	Installation Manual, Instruction Book	
	Accessory	Strainer, Heat insulation material, 2 x Connector sets	
Optional parts		NONE	
Remark		Details on foundation work, duct work, insulation work, electrical wiring, power source switch, and other items shall be referred to the Installation Manual.	

Note: *1Nominal heating conditions
<R2-series>
Outdoor Temp. : 7°CDB/6°CWB (45°FDB / 43°FWB)
Pipe length : 7.5 m (24-9/16 ft)
Level difference : 0m (0ft)
Inlet water Temp 65°C Water flow rate 2.15m³/h

<WR2-series>
Circulating water Temp. : 20°C (68°F)
Pipe length : 7.5 m (24-9/16 ft)
Level difference : 0m (0ft)
Inlet water Temp 65°C Water flow rate 2.15m³/h

*2Do not use refrigerant other than the type indicated in the manuals provided with the unit and on the nameplate.
- Doing so may cause the unit or pipes to burst, or result in explosion or fire during use, during repair, or at the time of disposal of the unit.
- It may also be in violation of applicable laws.
- MITSUBISHI ELECTRIC CORPORATION cannot be held responsible for malfunctions or accidents resulting from the use of the wrong type of refrigerant.

- * Due to continuing improvement, the above specifications may be subject to change without notice.
- * The unit is not designed for outside installations.
- * Please don't use the steel material for the water piping material.
- * Please always make water circulate or add the brine to the circulation water when the ambient temperature becomes 0°C (32°F) or less.
- * Please always make water circulate or pull out the circulation water completely when not using it.
- * Please do not use groundwater and well water.
- * Install the unit in an environment where the wet bulb Temp. will not exceed 32°C (90°F).
- * The water circuit must use the closed circuit.
- * Please do not use it as a drinking water.

Unit converter	
kcal	=kW x 860
BTU / h	=kW x 3,412
cfm	=m³ / min x 35.31
lbs	=kg / 0.4536

* The specification data is subject to rounding variation.

HEX Unit



Model		PWFY-P100VM-E1-AU		PWFY-P200VM-E1-AU	
Power source		1 - phase 220 - 230 - 240V 50 / 60Hz		1 - phase 220 - 230 - 240V 50 / 60Hz	
Heating capacity (Nominal)	*1 kW	12.5		25.0	
	*1 kcal / h	10,800		21,500	
	*1 BTU / h	42,700		85,300	
Power input	kW	0.015		0.015	
	Current input	A		A	
		0.068 - 0.065 - 0.063		0.068 - 0.065 - 0.063	
Temp. range of heating	Outdoor unit/Heat source unit condition	W.B.	-15 ~ 15°C (5 ~ 60°F) S - series		-
		W.B.	-20 ~ 15.5°C (-4 ~ 60°F) Y - series		-20 ~ 15.5°C (-4 ~ 60°F) Y - series
		W.B.	-25 ~ 15.5°C (-13 ~ 60°F) HP(ZUBADAN) - series		-25 ~ 15.5°C (-13 ~ 60°F) HP(ZUBADAN) - series
	HEX unit inlet water temp.	W.B.	-20 ~ 32°C (-4 ~ 90°F) R2 - series		-20 ~ 32°C (-4 ~ 90°F) R2 - series
		-	10~45°C (50~113°F) WY - series		10~45°C (50~113°F) WY - series
		-	10~45°C (50~113°F) WR2 - series		10~45°C (50~113°F) WR2 - series
Cooling capacity (Nominal)	*2 kW	11.2		22.4	
	*2 kcal / h	9,600		19,300	
	*2 BTU / h	38,200		76,400	
Power input	kW	0.015		0.015	
	Current input	A		A	
		0.068 - 0.065 - 0.063		0.068 - 0.065 - 0.063	
Temp. range of cooling	Outdoor unit/Heat source unit condition	D.B.	-5 ~ 46°C (23 ~ 115°F) Y - series		-5 ~ 46°C (23 ~ 115°F) Y - series
		D.B.	-5 ~ 43°C (23 ~ 110°F) HP(ZUBADAN) - series		-5 ~ 43°C (23 ~ 110°F) HP(ZUBADAN) - series
		D.B.	-5 ~ 46°C (23 ~ 115°F) R2 - series		-5 ~ 46°C (23 ~ 115°F) R2 - series
	HEX unit inlet water temp.	-	10~45°C (50~113°F) WY - series		10~45°C (50~113°F) WY - series
		-	10~45°C (50~113°F) WR2 - series		10~45°C (50~113°F) WR2 - series
		-	10 ~ 35°C (50 ~ 95°F)		10 ~ 35°C (50 ~ 95°F)
Connectable outdoor unit/heat source unit	Total capacity	50~100% of outdoor unit/heat source unit capacity		50~100% of outdoor unit/heat source unit capacity	
	Model / Quantity	Y (Standard, Hi-COP), Replace Y, HP(ZUBADAN) series, R2 (Standard, Hi-COP), Replace R2, WY series, WR2 series		Y (Standard, Hi-COP), Replace Y, HP(ZUBADAN) series, R2 (Standard, Hi-COP), Replace R2, WY series, WR2 series	
Sound pressure level (measured in anechoic room)		dB <A> 29		29	
Diameter of refrigerant pipe	Liquid	mm (in.) ø9.52 (ø3/8") Brazed		ø9.52 (ø3/8") Brazed	
	Gas	mm (in.) ø15.88 (ø5/8") Brazed		ø19.05 (ø3/4") Brazed	
Diameter of water pipe	Inlet	mm (in.) PT3/4 Screw		PT 1 Screw	
	Outlet	mm (in.) PT3/4 Screw		PT 1 Screw	
Field drain pipe size	mm (in.)	ø32 (1-1/4")		ø32 (1-1/4")	
External finish		NO		NO	
External dimension H x W x D		mm 800 (785 without legs) x 450 x 300		800 (785 without legs) x 450 x 300	
		in. 31-1/2" (30-15/16" without legs) x 17-3/4" x 11-13/16"		31-1/2" (30-15/16" without legs) x 17-3/4" x 11-13/16"	
Net weight		kg (lbs) 35 (78)		38 (84)	
Circulating water	Operation Volume Range	m³ / h 1.1 ~ 2.15		1.8 ~ 4.30	
	Design pressure	R410A	MPa 4.15		4.15
	Water	MPa 1.00		1.00	
Drawing	External	KD94R274		KD94R274	
	Wiring	WKE94C626		WKE94C626	
Standard attachment	Document	Installation Manual, Instruction Book		Installation Manual, Instruction Book	
	Accessory	Strainer, Heat insulation material, 2 x Connector sets, Flow switch x 1 set, wire		Strainer, Connector, Heat insulation material, 2 x Connector sets, Expansion joint, Flow switch x 1 set, wire	
Optional parts		Solenoid valve kit: PAC-SV01PW-E		Solenoid valve kit: PAC-SV01PW-E	
Remark		Details on foundation work, duct work, insulation work, electrical wiring, power source switch, and other items shall be referred to the Installation Manual.		Details on foundation work, duct work, insulation work, electrical wiring, power source switch, and other items shall be referred to the Installation Manual.	

Note: *1Nominal heating conditions
<S/Y/HP(ZUBADAN)/R2-series>
Outdoor Temp. : 7°CDB/6°CWB (45°FDB / 43°FWB)
Pipe length : 7.5 m (24-9/16 ft)
Level difference : 0m (0ft)
Inlet water Temp 30°C
Water flow rate 2.15m³/h(P100), 4.30m³/h(P200)

<WY/WR2-series>
Circulating water Temp. : 20°C (68°F)
Pipe length : 7.5 m (24-9/16 ft)
Level difference : 0m (0ft)
Inlet water Temp 30°C
Water flow rate 2.15m³/h(P100), 4.30m³/h(P200)

*2Nominal cooling conditions
<Y/HP(ZUBADAN)/R2-series>
Outdoor Temp. : 35°C (95°FDB)
Pipe length : 7.5 m (24-9/16 ft)
Level difference : 0m (0ft)
Inlet water Temp 23°C
Water flow rate 1.93m³/h(P100), 3.86m³/h(P200)

<WY/WR2-series>
Circulating water Temp. : 30°C (86°F)
Pipe length : 7.5 m (24-9/16 ft)
Level difference : 0m (0ft)
Inlet water Temp 23°C
Water flow rate 1.93m³/h(P100), 3.86m³/h(P200)

- * Due to continuing improvement, the above specifications may be subject to change without notice.
- * The unit is not designed for outside installations.
- * Please don't use the steel material for the water piping material.
- * Please always make water circulate or add the brine to the circulation water when the ambient temperature becomes 0°C (32°F) or less.
- * Please always make water circulate or pull out the circulation water completely when not using it.
- * Please do not use groundwater and well water.
- * Install the unit in an environment where the wet bulb Temp. will not exceed 32°C (90°F).
- * The water circuit must use the closed circuit.
- * Please do not use it as a drinking water.

Unit converter	
kcal	=kW x 860
BTU / h	=kW x 3,412
cfm	=m³ / min x 35.31
lbs	=kg / 0.4536

* The specification data is subject to rounding variation.

Controller Remote Controller

PAR-W21MAA



○ : Each group × : Not available

Item	Description	Operations	Display
ON / OFF	Runs and stops the operation of a group of units	○	○
Operation mode switching	Switches between Hot Water / Heating / Heating ECO / Anti - freeze / Cooling * Available operation modes vary depending on the unit to be connected. * Switching limit setting can be made via a remote controller.	○	○
Water temperature setting	Temperature can be set within the ranges below. (in increments of 1°C or 1°F) Heating 30°C ~ 50°C Heating ECO 30°C ~ 45°C Hot Water 30°C ~ 70°C Anti-freeze 10°C ~ 45°C Cooling 10°C ~ 30°C * The settable range varies depending on the unit to be connected.	○	○
Preset temperature range limit	Preset temperature range setting can be limited via a remote controller.	○	○
Water temperature display	10°C ~ 90°C (in increments of 1°C or 1°F) * The settable range varies depending on the unit to be connected.	×	○
Permit / Prohibit local operation	Individually prohibits operations of each local remote control function : ON / OFF, Operation modes, water temperature setting, Circulating water replacement warning reset. * Upper level controller may not be connected depending on the unit to be connected.	×	○
Schedule operation	ON / OFF / Water temperature setting can be done up to 6 times one day in the week. (in increments of a minute)	○	○
Error display	When an error is currently occurring on a unit, the afflicted unit and the error code are displayed.	×	○
Self check (Error history)	Searches the latest error history by pressing the CHECK button twice.	○	○
Test run	Enables the Test run mode by pressing the TEST button twice. * Test run mode is not available depending on the unit to be connected.	○	○
Circulating water replacement warning	Displays the circulating water replacement warning via the unit message. Clears the display by pressing the CIR.WATER button twice. * Circulating water replacement warning is not available depending on the unit to be connected.	○	○
Operation locking function	Remote controller operation can be locked or unlocked. · All-switch locking · Locking except ON / OFF switch	○	○



Centralized Controller

AG-150A

□ : Each unit ○ : Each group ● : Each block ▲ : Each floor ⊙ : Collective × : Not available

Item	Description	Operations	Display
Controllable unit	50 units / groups or 150 units / groups via expansion controller ; PAC-YG50ECA. (including air conditioning unit)	○ ● ▲ ●	○ ●
ON / OFF	Runs and stops the operation of a group of units	○ ● ▲ ●	○ ●
Operation mode switching	Switches between Hot Water / Heating / Heating ECO / Anti - freeze / Cooling * Available operation modes vary depending on the unit to be connected. * Switching limit setting can be made via a remote controller.	○ ● ▲ ●	○
Water temperature setting	Temperature can be set within the ranges below. (in increments of 1°C or 1°F) [Booster unit]** [Water HEX unit]** Heating 30°C ~ 50°C (87°F ~ 122°F) Heating 30°C ~ 45°C (87°F ~ 113°F) Heating ECO*** Invalid Heating ECO*** Invalid Hot Water 30°C ~ 70°C (87°F ~ 158°F) Hot Water Invalid Anti-freeze 10°C ~ 45°C (50°F ~ 113°F) Anti-freeze 10°C ~ 45°C (50°F ~ 113°F) Cooling Invalid Cooling 10°C ~ 30°C (50°F ~ 87°F) * The settable range varies depending on the unit to be connected. ** "Air To Water" on the AG-150A screen indicates Booster unit group and Water HEX unit group. *** The temperature is controlled automatically in the Heating ECO. The user cannot change the temperature settings.	○ ● ▲ ●	○
Water temperature display	10°C ~ 90°C (in increments of 1°C or 1°F) * The settable range varies depending on the unit to be connected.	×	○
Permit / Prohibit local operation	Individually prohibit operation of each local remote control function (Start / Stop, Change operation mode, Set temperature).	○ ● ▲ ●	○
Schedule operation	Group is the smallest unit to which a weekly schedule can be assigned. The same schedule can be applied collectively, or to each group, groups in a block, or groups on a floor. • Up to 24 events can be scheduled for each day. • "ON/OFF", "Operation mode", "Temperature Setting", and "Permit / Prohibit local operation" can be scheduled. • Five types of weekly schedule patterns (summer and winter) are available. • Five operation patterns (A-E) can be set for each year, up to 50 days can be allocated to each pattern.	○ ● ▲ ●	○
Error display	When an error is currently occurring on an unit, the afflicted unit and the error code are displayed.	×	□ ●
Test run	This operates air conditioner units in test run mode.	○ ● ▲ ●	○
External input / output	By using optional external input / output adaptor (PAC-YG10HA) you can set and monitor the following. Input : By level signal : "Batch start / stop", "Batch emergency stop" By pulse signal : "Batch start / stop", "Enable / disable local remote controller" Output : "Start / stop", "Error / Normal"	⊙	⊙

Note: Operation and displayed content vary depending on the indoor unit model.
Refer to the CITY MULTI catalog for the air conditioning control systems.

Advanced touch controller

AT-50A



□ : Each unit ○ : Each group ● : Each block ▲ : Each floor ⊙ : Collective × : Not available

Item	Description	Operations	Display
Controllable unit	50 units / groups of units		
ON / OFF	ON and OFF operation of a group of units. Even when only a single ATW unit or indoor unit is operated in the system, the advanced touch controller will operate and collective ON/OFF lamp will light up.	○ ⊙	○ ⊙
Operation mode switching	Switches between Hot Water / Heating / Heating ECO / Anti - freeze / Cooling * Available operation modes vary depending on the unit to be connected.	○ ⊙	○ ⊙
Water temperature setting	Temperature can be set within the ranges below. (in increments of 1°C or 1°F) [Booster unit] [Water HEX unit] Heating 30°C ~ 50°C (87°F ~ 122°F) Heating 30°C ~ 45°C (87°F ~ 113°F) Heating ECO** 30°C ~ 45°C (87°F ~ 113°F) Heating ECO** 30°C ~ 45°C (87°F ~ 113°F) Hot Water 30°C ~ 70°C (87°F ~ 158°F) Hot Water Invalid Anti-freeze 10°C ~ 45°C (50°F ~ 113°F) Anti-freeze 10°C ~ 45°C (50°F ~ 113°F) Cooling Invalid Cooling 10°C ~ 30°C (50°F ~ 87°F) * The settable range varies depending on the unit to be connected. ** The temperature is controlled automatically in the Heating ECO mode. The user cannot change the temperature settings.	○ ⊙	○ ⊙
Water temperature display	10°C ~ 90°C (in increments of 1°C or 1°F)	×	○
Permit / Prohibit local operation	Individually prohibit operation of each local remote control function (Start / Stop, Change operation mode, Set temperature, Circulating water replacement warning reset).	○ ⊙	○ ⊙
Schedule operation	Weekly schedule setting up to 12 patterns is available. In one pattern, up to 16 settings of "ON / OFF", "Operation mode", "Temperature Setting", and "Permit / Prohibit local operation" can be scheduled. Two types of weekly schedule patterns (summer and winter) are available. Today's schedule setting up to 5 patterns is available. * Time setting unit: 5 minutes / unit	○	○
Error display	When an error is currently occurring on a unit, the afflicted unit and the error code are displayed. * When an error occurs, the "ON / OFF" LED flashes. The operation monitor screen show abnormal icon over the unit. The error monitor screen shows the abnormal unit address and error code. The error log monitor screen shows the time and date, the abnormal unit address, error code, and source of detection.	×	□ ⊙

Optional Parts Solenoid Valve kit

Note:

When you intend to adopt PWFY-AU with below system configuration, you may need to use optional part (PAC-SV01PW-E). Please contact your Mitsubishi Electric sales office for details.

Applicable System

System Configuration

Y, HP(ZUBADAN), Replace Y, or WY* + PWFY-AU + Indoor Unit

*Solenoid valve kit will be used only when operating the WY at the water temperature below 10°C.

PAC-SV01PW-E

Item	Description	
Power source	1 - phase 220 - 230 - 240V 50 / 60Hz	
Diameter of refrigerant pipe	Applicable models	
	Liquid	PWFY-P100VM-E1-AU PWFY-P200VM-E1-AU
	Gas	mm (in.) ø15.88 ø19.05 mm (in.) ø9.52 ø9.52
External dimension H × W × D	mm	462 × 320 × 207
	in.	18-1/4" × 12-5/8" × 8-3/16"
Net weight	kg (lbs)	8.5 (19)
Drawing	External	WKD94T532
Standard attachment	Document	Installation Manual
	Accessory	Specification label, Refrigerant conn.pipe



for a greener tomorrow

Eco Changes is the Mitsubishi Electric Group's environmental statement, and expresses the Group's stance on environmental management. Through a wide range of businesses, we are helping contribute to the realization of a sustainable society.



FM33568 / ISO 9001:2008

The Air Conditioning & Refrigeration Systems Works acquired ISO 9001 certification under Series 9000 of the International Standard Organization (ISO) based on a review of Quality management for the production of refrigeration and air conditioning equipment.

ISO Authorization System

The ISO 9000 series is a plant authorization system relating to quality management as stipulated by the ISO. ISO 9001 certifies quality management based on the "design, development, production, installation and auxiliary services" for products built at an authorized plant.



The Air Conditioning & Refrigeration Systems Works acquired environmental management system standard ISO 14001 certification.

The ISO 14000 series is a set of standards applying to environmental protection set by the International Standard Organization (ISO). Registered on March 10, 1998.

⚠ Warning

■ Do not use refrigerant other than the type indicated in the manuals provided with the unit and on the nameplate.

- Doing so may cause the unit or pipes to burst, or result in explosion or fire during use, during repair, or at the time of disposal of the unit.
- It may also be in violation of applicable laws.
- MITSUBISHI ELECTRIC CORPORATION cannot be held responsible for malfunctions or accidents resulting from the use of the wrong type of refrigerant.

MITSUBISHI ELECTRIC CORPORATION

<http://Global.MitsubishiElectric.com>